

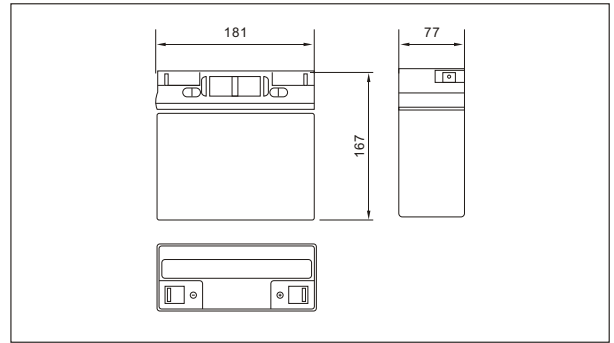

SW12160(12V16AH)



Outer dimensions (mm)



Specifications

Nominal Voltage		12V
Rated capacity (20 hour rate)		16Ah
Dimensions	Total Height	167 mm (6.57 inches)
	Height	167 mm (6.57 inches)
	Length	181 mm (7.13 inches)
	Width	77 mm (3.03 inches)
Weight Approx		5.0 Kg (11.02 lbs)

Terminal Type (mm)

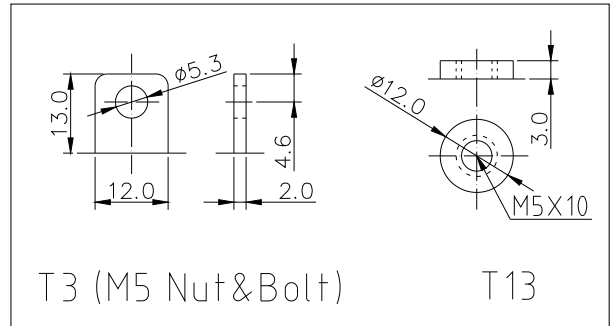

Characteristics

Capacity 25°C(77°F)	20 hour rate(0.8A)	16.0 AH
	10 hour rate(1.47A)	14.7AH
	5 hour rate(2.70A)	13.6AH
	1 hour rate(0.96A)	9.6 AH
	1.5 hour discharge to 10.5V	6.8 A
Internal Resistance	Full charged Battery at 25°C(77°F)	16 mΩ
Capacity affected by Temperature (20hour rate)	40°C(104°F)	102%
	25°C(77°F)	100%
	0°C(32°F)	85%
	-15°C(5°F)	65%
Self-Discharge at 25°C(77°F)	Capacity after 3 month storage	91%
	Capacity after 6 month storage	82%
	Capacity after 12 month storage	64%
Terminal		T3 or T13
Charge (constant Voltage)	Cycle	Initial Charging Current less than 6.4A Voltage 14.40-14.70V
	Float	Voltage 13.50-13.80V

Discharge Curves 25°C(77°F)

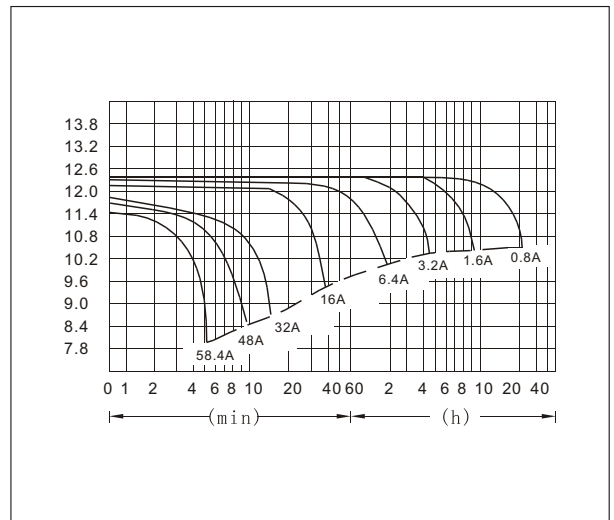

Time		5min	10min	15min	30min	1h	2h	3h	4h	5h	8h	10h	20h
9.60V	A	57.6	37.8	28.0	18.4	9.6	5.60	4.12	3.31	2.81	1.85	1.51	0.83
	W	598	405	300	198	104	61.5	45.9	37.2	31.9	21.3	17.5	9.6
10.20V	A	52.8	36.1	25.7	17.5	9.0	5.37	4.00	3.20	2.75	1.82	1.49	0.81
	W	567	404	288	196	102	61.9	46.3	37.2	32.1	21.3	17.5	9.5
10.50V	A	48.1	33.8	24.0	16.9	8.7	5.27	3.93	3.04	2.74	1.80	1.47	0.80
	W	528	384	274	195	101	61.1	45.8	35.6	31.9	21.2	17.4	9.5
10.80V	A	46.2	32.3	22.4	16.5	8.4	5.13	3.87	2.99	2.60	1.75	1.43	0.78
	W	518	372	258	191	98	60.1	45.6	35.3	30.7	20.8	17.1	9.3
11.10V	A	42.7	30.4	20.8	16.0	8.1	5.00	3.67	2.93	2.49	1.71	1.40	0.76
	W	485	352	242	187	95	59.1	43.5	34.9	29.7	20.5	16.9	9.2